

VectorStar™

MS4640A Series

70 kHz to 70/110/500 GHz and Beyond

Family of RF to Microwave and Millimeter-wave
Vector Network Analyzers

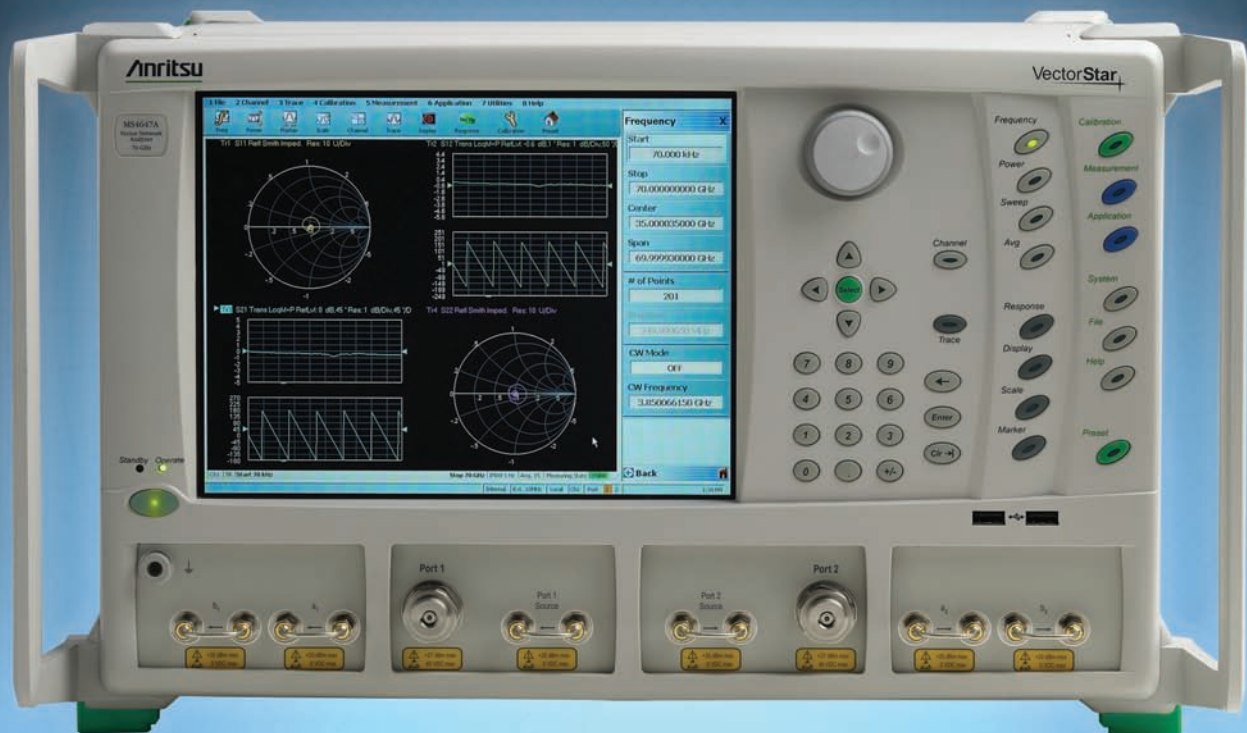

Performance . . .

70 kHz to 70 GHz Opens a World of Possibilities

Building on design experience of more than 40 years, Anritsu has now broken the RF barrier with the VectorStar MS4640A Series — spanning from 70 kHz to 70 GHz in a single connector.

The VectorStar VNA offers a new performance benchmark for S-parameter measurements of RF, Microwave, and Millimeter-wave devices. And with this latest breakthrough Anritsu now provides RF and Microwave engineers a powerful measurement tool for performance analysis of devices ranging from transistors in an on-wafer environment to communication systems in commercial or defense applications.



A new level of performance for the most demanding requirements

Broadest frequency span from a single coaxial test port covering 70 kHz to 70 GHz in a single instrument and 70 kHz to 110/500 GHz in the Broadband configuration	<ul style="list-style-type: none"> • Obtain the most thorough and accurate broadband device characterization • Eliminate the time consuming, error prone concatenation process across the RF, microwave, and millimeter-wave bands • Decrease test instrument expenses • Reduce the risk of DC extrapolation errors in your device modeling
Superior dynamic range: up to 140 dB	<ul style="list-style-type: none"> • Accurately measure medium and high loss devices • Catch all potential filter feed-throughs in out-of-band regions • Quickly and easily perform high-sensitivity antenna measurements
Fastest swept synthesized measurement speed: < 20 usec per point	<ul style="list-style-type: none"> • Increase manufacturing revenue by increasing throughput • Reduce the risk of shipping defective products, by spotting the most difficult to find failures quickly and easily.
High available power: up to +13 dBm	<ul style="list-style-type: none"> • Eliminate the need for an external amplifier • Reduce your test setup costs • Accurately test your non-linear devices with no compromises
High compression point level: up to +15 dBm at 70 GHz	<ul style="list-style-type: none"> • Eliminate the need for internal or external attenuators • Improve calibration and measurement accuracy
Best test port characteristic performance: up to 50 dB in directivity, source match and load match	<ul style="list-style-type: none"> • Reduce measurement uncertainty • Reduce measurement guard bands • Improve productivity • Achieve optimum precision measurements in the R&D lab
Most convenient automatic calibration system with best accuracy	<ul style="list-style-type: none"> • Use Precision AutoCal® for an easy, one-button method of VNA calibration • Better accuracy than traditional SOLT calibration • Spend less time setting up the VNA for the next production run
Highest data resolution utilizing 100,000 points for maximum flexibility	<ul style="list-style-type: none"> • Zoom in on narrow band responses without re-calibration • Calibrate the VectorStar once and have enough data points to test any narrow-band device at any frequency
Best device modeling data.	<ul style="list-style-type: none"> • Accelerate your design cycle • Accurately model devices down to DC using calibrated, traceable values starting at 70 kHz • Eliminate the need for concatenation of two VNAs
Best time domain analysis	<ul style="list-style-type: none"> • 100,000 points and 700 kHz frequency step size provide the most accurate, highest resolved, Low Pass Mode measurements • Measure long transmission lines with the best non-aliasing range
4-port single-ended and balanced measurements	<ul style="list-style-type: none"> • Measure all 16 single-ended or mixed-mode responses • Flexible calibration routines, using a 2-port AutoCal • Excellent performance from 10 MHz to 70 GHz

... and Versatility

Sixteen Channels of Power and a Wealth of Traces to Display Your Data

Unique Dual Broadband Receiver combines two broadband systems in a single instrument. The low band option covers the 70 kHz to 10 MHz range and the high band section operates up to 70 GHz. The combined architecture spans an amazing 20 octave range!

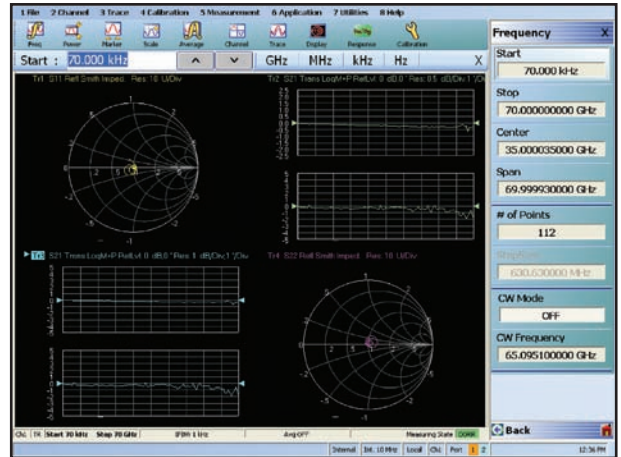

The fastest measurement time, versatile connectivity, and intuitive interface provide rapid system setup and measurements. Sixteen fully independent channels are the equivalent of 16 VNAs at your test station multiplexed to your display.

Each channel can be configured to display any internal measurement feature, from changes in frequency range, alternative calibration methods, to changes in domain setups.

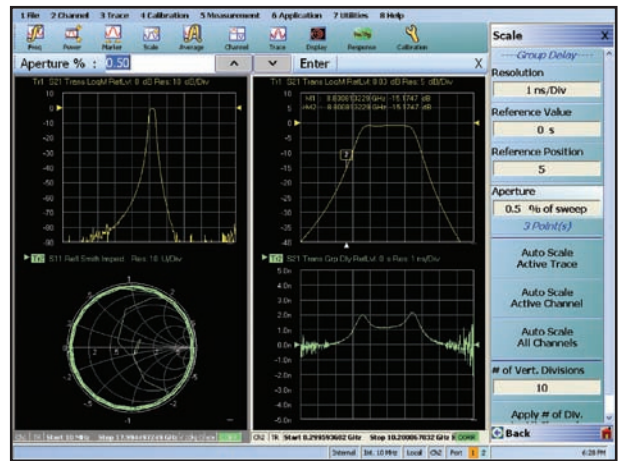

In a single setup you can capture and display the S-parameter performance of a device across the frequency of interest, the match at a specific location using time domain with maximum 70 GHz bandwidth resolution, and the gated performance at a specific location within the device. At the same time, zoom in on narrow bands of interest and perform additional analysis such as group delay and frequency response. You can configure each display for the best performance and accuracy by using optimum IF bandwidths.

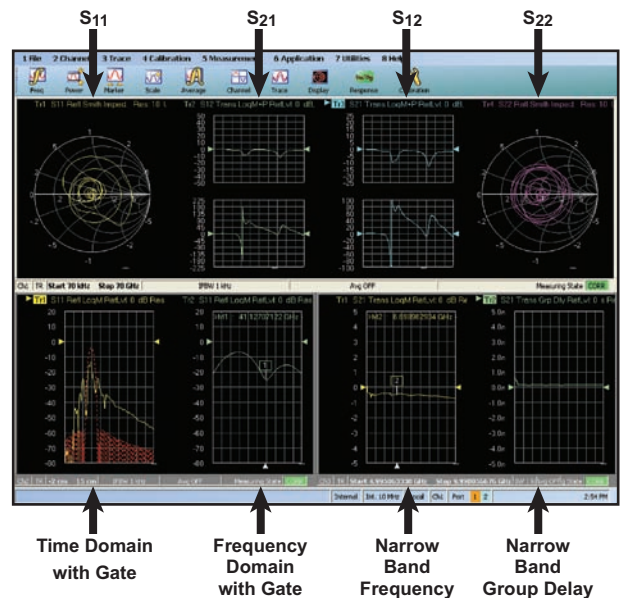

Fast . . .

Lightning Fast Measurements

- <20 usec per point of synthesized sweep speed
- Sweep the entire range of 70 kHz to 70 GHz in <4 msec

Not Just Fast Frequency Locking..... Fastest SWEEP Speed!

The true test of measurement speed is in a swept mode condition, rather than an unlocked, single-point, CW setting. The 20 usec per point measurement speed is consistently available in swept mode under true operating conditions. All measurement modes are fully phase-locked and synthesized. There are no hidden unlocked, analog sweep modes that can cause measurement errors or inadvertently degrade the calibration.

Fast and accurate measurements require more than circuitry quickly stepping through successive frequency points, they also require the ability to capture, transfer and handle vast amounts of data in a quick and organized manner. The VectorStar incorporates a powerful microprocessor and a custom DSP high speed data link to quickly transfer the data. Additionally, its use of direct memory access and deep memory buffers not only achieves fast frequency stepping, but also stores and manipulates vast amounts of data.

401 Points, Display On, Synthesized Frequency	1 GHz Span	70 GHz Span
Uncorrected	14 ms	50 ms
Corrected (2 port calibration per sweep)	14 ms	50 ms

Real Time Tuning

Now you can tune devices with the speed of a scalar analyzer and the accuracy of a VNA. Unlike other analyzers where speed compromises accuracy and trace noise, the VectorStar’s unique design architecture minimizes trace noise by using a more coherent Source/LO pair. The result is ultra-low trace noise without having to increase IF filtering thereby slowing the sweep speed. And speed is not limited to just the display. You can quickly download data to your external data base while moving on to the next device to maximize throughput.

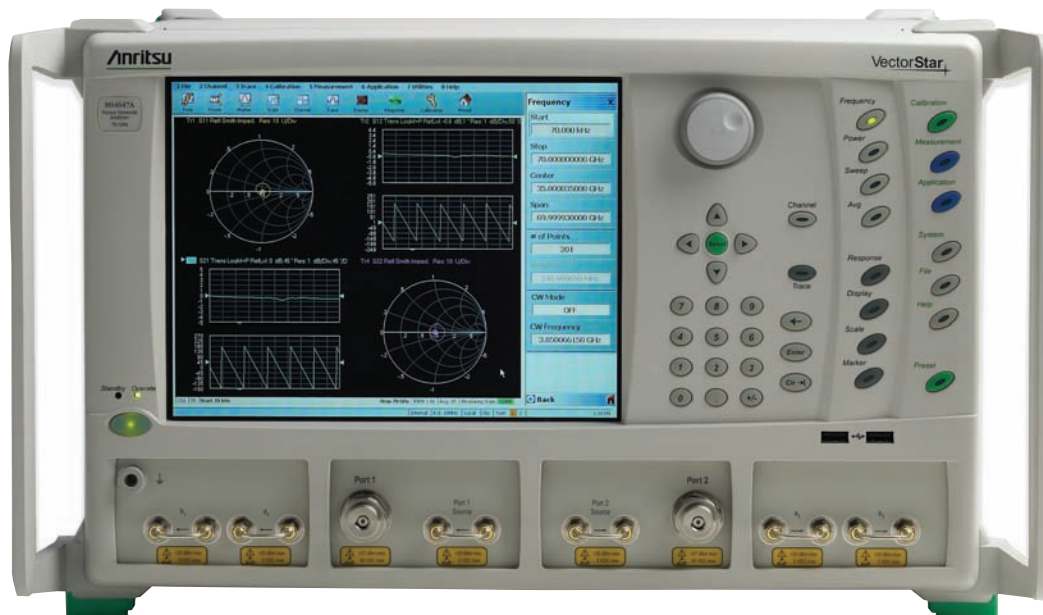

. . . and Precise

Best Dynamic Range

- 134 dB at 20 GHz
- 130 dB at 40 GHz
- 112 dB at 67 GHz
- 106 dB at 70 GHz

Thanks to incorporating two optimized VNAs in one instrument, the VectorStar delivers full spectrum performance. You're no longer subject to losing dynamic range at the low end of the frequency range due to coupler roll-off. Nor will you have to worry about the high end due to a drop in available port power. By utilizing high directivity couplers for the microwave region and resistive bridges for the RF range, critical performance parameters such as directivity and available measurement power are maximized. Add to that a receiver compression level up to 20 dB higher, and a noise floor up to 15 dB lower. The result is a VNA with the best overall dynamic range over the widest frequency range available in the industry.

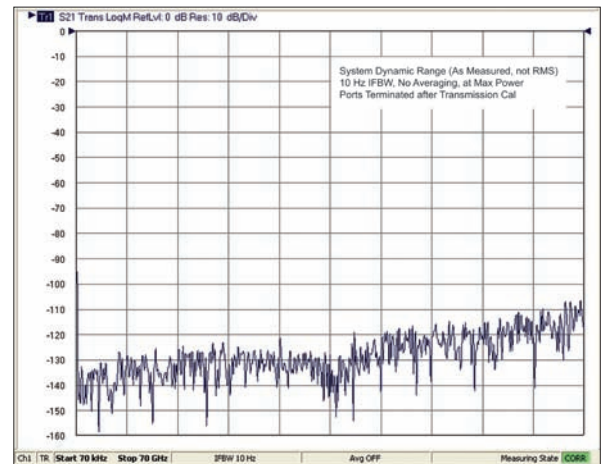

Widest Dynamic Range with Best Calibrated Accuracy

The methodology that enables the widest dynamic range over the broadest frequency span is the independent optimization of the RF and microwave regions. In addition, design considerations that optimize the down-conversion process are also included.

VNAs down-convert the RF signal to IF before analysis and typically use either samplers or mixers. Considerations of conversion efficiency, receiver compression levels, isolation, and spurious generation must be included in the design choice. When considering conversion efficiency for optimum dynamic range performance in the microwave region, the harmonic conversion process is usually preferred. And harmonic samplers often have better conversion efficiency compared to harmonic mixers, especially at higher frequencies (~>30 GHz).

The VectorStar VNA optimizes broadband dynamic range performance by utilizing harmonic sampler architecture and including Non Linear Transmission Line (NLTL) technology, also known as shock-line transmission. This technique, incorporating Anritsu patents, substantially minimizes the harmonic N roll-off and thereby provides the widest possible dynamic range at high frequencies. The figure illustrates typical differences in conversion efficiency between a standard SRD-driven harmonic sampler and a NLTL-driven harmonic sampler for a given LO frequency. At frequencies above 40 GHz, the transfer function of the SRD method typically begins to roll off. At 50 GHz the roll off is enough to significantly affect the dynamic range performance of the system. In the area above 50 GHz, the SRD method provides a challenging situation where the LO frequency may need to be constantly modified to minimize the loss in dynamic range performance. Conversely, the NLTL sampler does not exhibit the same roll off in conversion efficiency and thereby offers the best dynamic range performance. A further benefit of the NLTL shock-line harmonic sampler architecture is the excellent isolation between test channels which further improves effective noise floor performance.

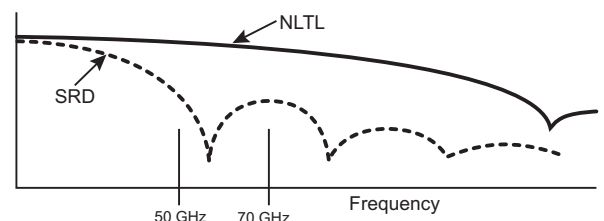

The overall benefit of the NLTL harmonic sampling technique used in VectorStar is an architecture providing the maximum available conversion efficiency with the highest receiver compression point. VectorStar can be calibrated at higher power levels before compression and still offer some of the best noise floor performance in the industry. For example, the 0.1 dB compression point at 70 GHz is up to +15 dBm compared to -10 dBm of other VNAs. The noise floor of VectorStar is specified at -115 dBm at 40 GHz compared to other VNAs at -95 to -105 dBm. And the advantage of a high compression level is more than system dynamic range performance. A high compression level minimizes the need for attenuators between the DUT and receiver port when measuring active devices. Insertion of attenuators reduces overall system accuracy by raising the noise floor and degrading signal to noise performance during calibration.

Flexible . . .

Optimum Device Testing

Careful consideration in VectorStar's RF architecture and component design results in a noise floor approaching kTB levels, a high receiver compression point for measuring high power level devices and ultra-stable low drift measurements long after calibration. Basic configuration of the VectorStar architecture includes the ability to measure a wide range devices. It features:

- The widest available frequency coverage –70 kHz to 70 GHz for best device characterization
- A wide range of device testing without concern for receiver compression errors, thanks to high input power capabilities at the receiver port.
- 100,000 points for maximum measurement flexibility and resolution. With a single click of a button, the VectorStar automatically calibrates using Precision AutoCal over the full frequency spectrum and 100,000 points. Then you can measure all of your devices without having to recalibrate due to a lack of calibration points when measuring narrow band devices. And since group delay accuracy is proportional to number of data points, you can obtain the highest measurement accuracy possible when measuring narrow band filters without the need to recalibrate.



Active Device Measurements

Add the Active Measurements Suite (Option 06x) to perform the most popular tests in a convenient, easy to use program.

This versatile application-oriented measurement system features:

- Choice of two or four internal step attenuators for forward and reverse sweeps.
- Internal bias tees
- Gain compression software to evaluate over swept frequency or swept power, or multiple CW frequencies.
- Extended power range control

Gain Compression Analysis

The powerful gain compression software application in VectorStar includes the ability to measure compression over multiple frequencies. And by using the multiple frequency gain compression configuration, the VNA will sweep power and detect the selected compression point at up to 401 frequencies. The results are then displayed in graphical and tabular format.

Total Compatibility with Wafer-Probe Stations and On-wafer Calibration Software

Integrate the VectorStar with probe stations from leading probe manufacturers for making accurate on-wafer measurements in both microwave and millimeter-wave bands. Compatibility with calibration software enables fast automated calibrations for accurate measurements of discrete FETs, MMICs, passive components, and others. In addition, the format and communication capabilities of the VectorStar-based Broadband system provide compatibility with popular computer-aided design and test packages. This enables transfer of S-parameter data files (SnP) from the network analyzer directly into microwave design simulation environment.

Device characterization and parameter extraction are most commonly performed on a wafer probe system requiring specific on-wafer calibration methods. The VectorStar provides an easy interface for entering the parameters for SOLT, LRL, and LRM calibrations. Other external calibration techniques, optimized for wafer probing applications, are also supported for users of probe systems.

. . . and Customizable

Direct Access to Source and Receiver Ports, Extensive Menu Configuration, and Built-in Applications

Independent offset modes provide optimum performance and flexibility for applications where the stimulus and receiver frequencies must be offset. Mixers, up/down converters, IMD, and harmonic content can now be measured with ease and accuracy. Additional capabilities such as flat test port power, embedding/de-embedding of networks, and modifiable reference impedance, provide complete control of the measurement setup configuration.

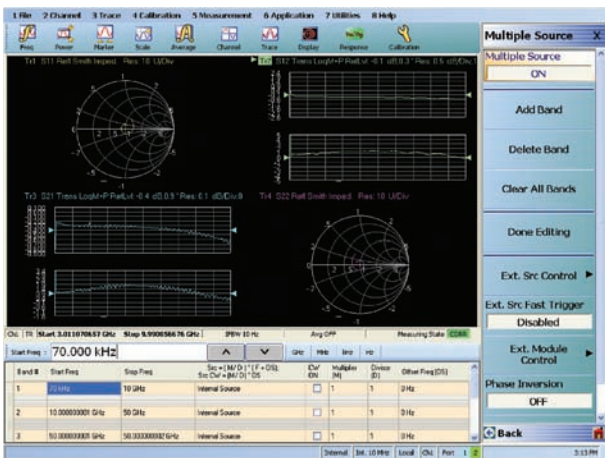

Receiver Offset

The Receiver Offset Option (Option 007) provides fully synthesized and fully independent source and receiver functions for mixer, harmonics, IMD and other measurements where the source and receiver are at different frequencies.

It also includes Multiple Source Control module, which provides a menu-driven capability to control up to four external sources in addition to the internal source and receiver. Control of external sources is completely synchronized to provide the ability to test devices under conditions where phase coherency is a must.

Frequency Translated Measurements

Included with the Receiver Offset Option is the NxN Mixer Calibration and Measurement utility, providing an accurate method of measuring frequency translated devices. The utility provides both magnitude and phase information as well as the unique ability to measure absolute phase and group delay. By measuring the response characteristics of device pairs, the VectorStar will solve and de-embed the device characteristics. The NxN application module includes capabilities for characterizing and de-embedding the IF path of frequency translation device measurements and delivering a real-time display of the de-embedding characteristics of the device under test for magnitude and absolute phase.

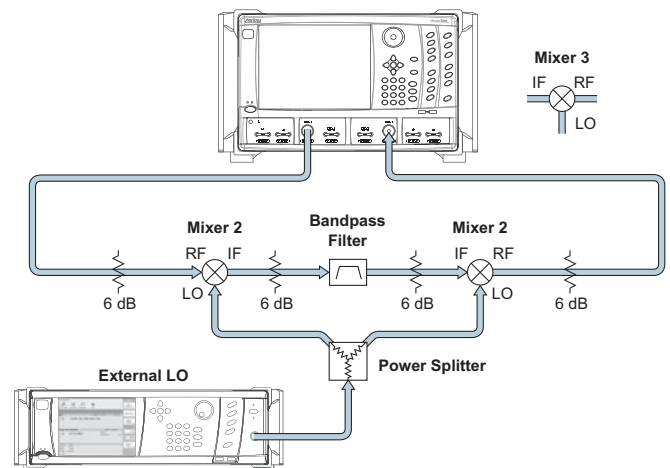

Application Ready . . .

Time Domain

The Time Domain Option (Option 002) allows you to display the performance of the device in the time or distance domain. It also provides a powerful ability to analyze the performance of the device at specific location points of interest. For instance, when analyzing connectors, the distance information provides an indicator of the quality of the connection at different locations within the connector.



Unique Time Domain Analysis Benefits

Three important parameters of a VNA have a direct impact on the quality and performance of Time Domain analysis:

Frequency Span

The wider the frequency span, the better the resolution in the Time Domain display. The wider span provides the resolution needed to resolve discontinuities that are too close together to be analyzed by a narrow-swept VNA (See Figure 1).

Low-end Frequency

With up to 100,000 points available, low pass time domain measurement can start at a frequency of 700 kHz using the required harmonic calibration frequency plan, by far the lowest available in any VNA. As a result, the VectorStar will provide near-DC extrapolation values for the preferred low pass mode operation and the most accurate display of time domain analysis available.

100,000 Data Points

Simply the maximum data point available for a VNA resulting in the widest alias-free range for a time domain display. Now you have the ability to measure transmission lines, such as optical cables, of extreme long lengths.

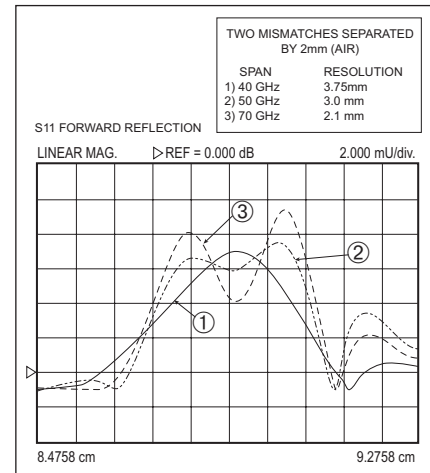

Figure 1, A Wide Frequency Sweep is needed if the application calls for identifying closely spaced reflections.

70 kHz to 70 GHz Provide Unprecedented Resolution

The unprecedented low-end frequency range of the VectorStar provides a unique opportunity when using Time Domain analysis, especially when using the popular Low-Pass Step mode. This powerful processing technique provides the highest performance and most versatile set of displays. The Low-Pass mode requires a harmonically related set of frequencies that start at the lowest frequency possible. A DC term is extrapolated that provides a phase reference, so the true nature of a discontinuity can be evaluated. Now, with a maximum of 100,000 points and a starting frequency of 700 kHz, the DC term extrapolation can begin at a near-DC data point. The result is a significant improvement in the capabilities of device analysis when analyzing in the Low-Pass Time Domain.

The VectorStar continues to offer the Anritsu unique benefit of providing both real and imaginary information when measuring narrow band devices such as bandpass filters and waveguide. The Anritsu-developed Phasor Impulse Mode provides true impedance information of these type of devices even when operating Time Domain Band Pass mode.

. . . and Upgradeable

Your Investment is Protected

- Automatically receive software, firmware, and selected hardware upgrades with the Dynamic Protection Package.
- Increase frequency coverage, measurement suites, and firmware applications by upgrading your VectorStar when ready.

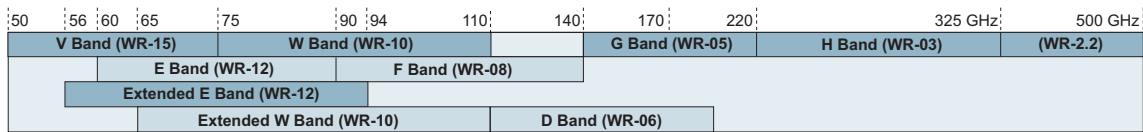
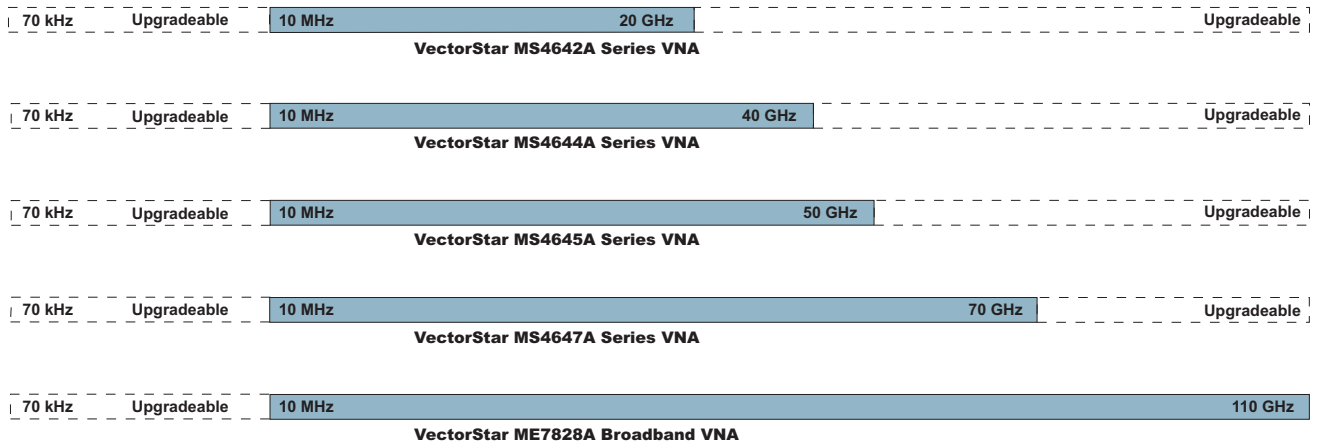

Flexible configuration options offer the exact performance and capabilities you need. With the Dynamic Protection Package your VectorStar will be automatically upgraded to the latest level of performance during the warranty period thereby ensuring your investment is at peak performance.

In addition to maintaining a peak level of measurement performance, each model also can be upgraded to a broader frequency range. For example, you can start with a standard configuration (10 MHz to 20 GHz), and later expand your VectorStar, to perform device characterization ranging from 70 kHz to 110 GHz.

Upgrade Existing VNA Systems to the Level of VectorStar

The VectorStar also can be used to upgrade the performance of existing legacy systems, by the incorporation of the flexible programming interface.

Existing broadband and millimeter-wave systems using the Lightning VNA can easily be upgraded to the VectorStar level by simply replacing the VNA. The upgraded broadband system will offer operation down to 70 kHz, extended dynamic range, and the fastest broadband measurement speed from 70 kHz to 110 GHz, all through a single 1 mm coaxial output.

Even Upgrade Your Existing HP8510 System

Using standard GPIB programming commands, you can upgrade your existing ATE system configured with the 8510 VNA to the performance level of VectorStar. Now you have the advantage of the best dynamic range, measurement speed, and data analysis in your familiar, existing ATE system.



Calibration Choices . . .

Optimum Measurement Accuracy for a Wide Range of Application Environments

- AutoCal module for automatic calibrations
- SOLT/SOLR for traditional mechanical calibrations
- LRL/LRM for metrology grade accuracy
- ALRM, SSLT to SSSR for on-wafer, waveguide and other unique requirements

Precision AutoCal

The most efficient calibration solution:

- Reduces calibration time and potential operator errors
- Improves accuracy over traditional SOLT by utilizing innovative characterization and calibration algorithms
- Performs the widest frequency span calibration in a single automatic calibration module: 70 kHz to 70 GHz
- Provides the largest number of internal characterization points for best accuracy simultaneously over a broad and narrow frequency span
- Combines the most number of characterized points with up to 100,000 instrument calibration points – all with a single click.



The concept of AutoCal was first introduced by Anritsu in 1998 to decrease the possibility of improper connections or connecting the wrong standard. Combining over-determined characterization algorithms with Anritsu's Multiple Line Calibration kit, the Precision AutoCal provides unprecedented accuracy. It now surpasses the accuracy of mechanical standards kits, including those with sliding loads, resulting in a simple to use calibration method providing metrology-grade performance.

Fast, Easy and Accurate Non-Insertable Measurements

Non-insertable measurements require the use of an adapter during the thru calibration setup. Often, extraction methods utilizing S2P files are used to remove the effects of the adapter. This requires yet another calibration and a challenge to perform the measurement with the desired degree of accuracy. That's why the Precision AutoCal module is available in a variety of connector configurations and can easily connect the non-insertable test ports to provide the most accurate alternative to non-insertable calibrations.

For cases where the correct connector version of AutoCal may not be available, VectorStar provides an easy method of incorporating an adapter during the thru calibration step. This improved method eliminates the need for additional S2P files. The procedure works in conjunction with the insertable AutoCal and simply requires reversing the combination and re-calibrating. The result is an automatic adapter removal calibration using only four connections (unlike other methods that require as many as 22 re-connections during the calibration procedure).

. . . for Manufacturing, R&D, or Metrology

Get Substantial Advancements in Automatic Calibration Performance with Precision AutoCal

Superior switching of internal standards coupled with the highest available calibration points provides the most accurate, stable, user-friendly automatic calibration system available for a VNA. And the unique topology of the AutoCal module provides a number of significant advances in automatic calibration procedure:

- Hybrid GaAs PIN diode technology with its unique standards mapping technique provides a wide range of impedance reference points without the high insertion loss of cascading multiple switches. With a wide variety of impedance points to choose from, the VectorStar over-determined algorithm finds the optimum characterization combination to provide the fastest, most accurate calibration possible. The higher number of available reference points coupled with over-determined characterization algorithms, provides wider reference coverage of the impedance map, increased source match accuracy, and minimization of interpolation errors across the entire Smith Chart.
- Turnstile approach to impedance switching provides a low insertion loss path between ports, up to 6 dB or better, for a far more accurate through-path characterization and superior transmission tracking performance.
- Get an accurate through-path characterization without the need to reconnect test port cables or perform an additional calibration step as with other electronic calibrators.
- A maximum number of over-characterized points, combined with an optimal segmented sweep, results in a calibrated step size as narrow as 20 kHz compared to 10 MHz for other electronic calibrators. The result is low interpolation errors, even when sweeping extremely narrow band ranges.
- Availability of the SOLR calibration routine for applications where transitions in connector types are required.
- AutoCal can also be characterized in the field with an adapter. No need to send the module back to the factory. When finished, the adapter can be removed and the initial characterization file restored to the original state.



Unsurpassed Accuracy

Accuracy is determined by numerous system performance aspects such as corrected test port characteristics and trace noise. Uncertainty curves provide a graphical representation of total system accuracy and offer a complete picture of precise and expected measurements. The overall test port characteristics of the VectorStar are unsurpassed, whether compared to traditional SOLT calibration kits or automated calibration methods. For example, note the significant advantage in accuracy of the VectorStar when calibrated with the Precision AutoCal and compared to other VNAs calibrated with similar automated calibration modules or even with traditionally more accurate mechanical calibration kits using sliding loads. Further proof that not only will VectorStar provide the most accurate measurements, it is also easy to calibrate and operate.

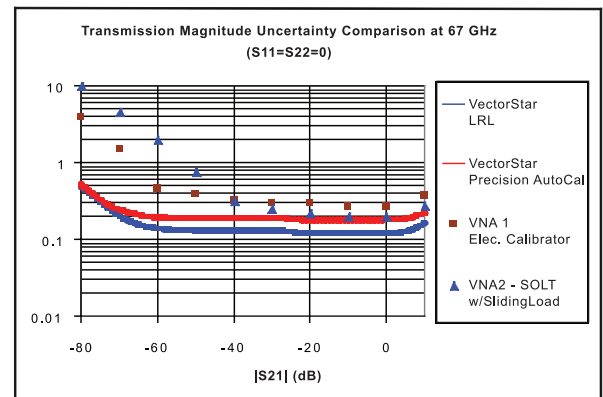

LRL/LRM Multiple Line Calibration Kits

Utilizing the new Model 3657 Series Multiple Line Calibration Kits from Anritsu, the VectorStar can be calibrated to unprecedented levels of performance. The six male-to-male beadless airlines contained in the 3657-1 Multiple Line calibration kit provide the highest level quality NIST traceable impedance standard. When calibrated with the internal LRL/LRM calibration routine, the VectorStar corrected Directivity and Load Match is specified to be up to 50 dB.

Full-Featured Front Panel . . .

- Access the features and functions of the VectorStar VNA through dedicated keys, touch screen, and mouse driven selections
- Input extensive data via your external keyboard
- Custom toolbars provide easy setup configurations for specific measurements.
- Select and organize up to 10 icons for fast selection of the most common measurements
- Increase security using the removable SATA hard drive accessible from the rear panel
- Free up USB ports by connecting your external keyboard and mouse to rear panel PS2 connectors
- Multiple sweep options include Frequency (lin or log), Power, and with Option 002, Frequency with Time Gate, and Time Domain (Low Pass or Band Pass)

Minimize menus and tool bars for optimum viewing of data.

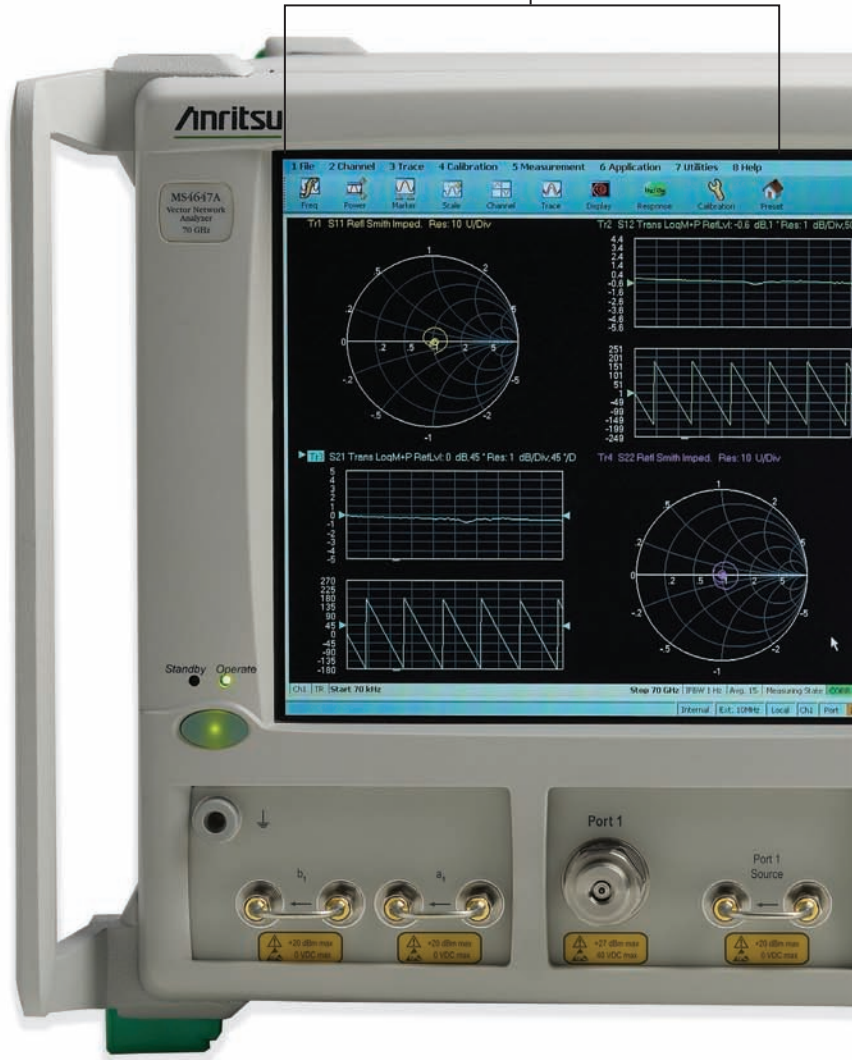

. . . for easy access to powerful functionality

Grouped by category and application, the hard keys provide all the control options dedicated to perform all front panel setups and measurements



One to 16 independent channels for maximum flexibility.

Add up to 16 traces to each channel for optimum data display

A single channel can provide as many as 100,000 data points. Multiple channels can provide up to 25,000 points per channel

Click and drag up to 13 decoupled markers per trace across the display with continuous updated readout.

Two USB ports on the front panel provide convenient access for flash drives, keyboards, and mouse operations.

From Broadband/mmWave System Solutions...

Industry's Only 70 kHz to 110 GHz Broadband Vector Network Analyzer

DC to Daylight

Finally, an instrument that truly lives up to the challenge. The VectorStar ME7828A broadband system provides an incredible frequency span of 70 kHz to 110 GHz through a single coaxial output. Operation down to 70 kHz provides 8 additional octaves of low end frequency information. With 70 kHz measured data, device modeling software can significantly improve DC extrapolation calculations thereby increasing the accuracy of their models.

Key Features

- Continuous Broadband Frequency Coverage from 70 kHz to 110 GHz using a 1 mm coaxial test port connector
- Banded Millimeter-wave Operation (up to 0.5 THz)
- Industry-best dynamic range: 100 dB at 110 GHz, typical
- Industry-best stability: 0.1 dB over 24 hours, typical
- Industry-best measurement speed: 200 ms for 401 points
- Best Time Domain performance: maximum resolution, longest non-aliasing range, accurate DC extrapolation down to 70 kHz, and 100,000 points for optimum low pass processing.
- Kelvin bias tees located in combiner is standard. Provides force, sense, and ground for optimum performance near device under test.

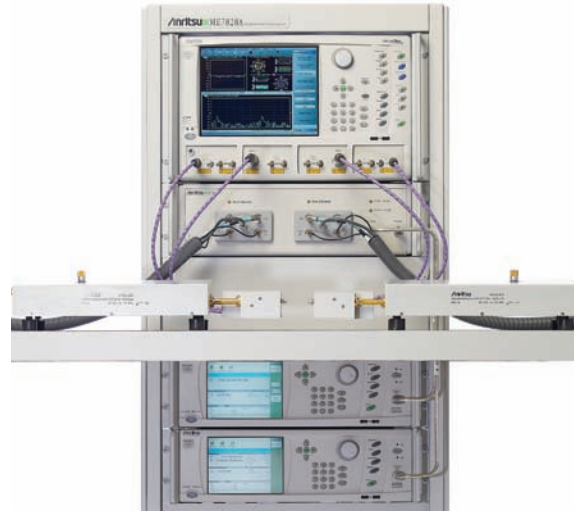

Applications

- Broadband Characterization
- Parameter Extraction
- Device Modeling
- On-wafer Measurements
- Millimeter-wave Measurements
- Time Domain Analysis

On-Wafer Measurements

The ME7828A Broadband Vector Network Analyzer is a high performance measurement solution offering the best overall performance for on-wafer measurements including:

- A wide range of on-wafer optimal calibration choices: SOLT/SOLR, LRL/LRM, A-LRM™
- Embedding/De-embedding including the ability to cascade multiple networks for extracting fixtures or embedding networks.
- Compatibility with SussCal, WinCal, and IC-CAP
- High port power to overcome insertion losses at the probe tip.
- Flat power calibration
- Merged calibrations

And when integrated into the SUSS SIGMA probe station, dynamic range performance improves by an additional 6 dB and measurement speed by a factor of 3 when measuring low level signals.



. . . to Multiport System Solutions

4-port Solutions up to 70 GHz

The MS4640A-series VectorStar 2-port VNA can be used in conjunction with an external MN469xB-series 4-port Test Set, for 70 kHz to 70 GHz single-ended and mixed-mode S-parameter measurements. The VectorStar 4-port solution is ideal for today's highly integrated multiport assemblies, common three-port devices such as combiners, diplexers, and couplers, and balanced linear devices.

Two models are offered, the MN4694B in K, and the MN4697B in V connector output. The former can be used with the MS4642A or MS4644A for 70 kHz to 20 GHz or 40 GHz coverage respectively. The latter can be used with the MS4645A or MS4647A for 70 kHz to 50 GHz or 70 GHz coverage respectively. The only option that is necessary on the base 2-port VNA is the Direct Access Loops available with Option 051. Option 070 is needed for coverage down to 70 kHz.

For Signal Integrity measurements on high speed balanced transmission lines and connectors, the VectorStar 4-port solution offers an unprecedented 70 kHz low end, operational to 40 kHz, on a Microwave VNA. Direct measurements from practically DC to 70 GHz, high accuracy time domain, and wide dynamic range frequency domain make the 4-port VectorStar the ideal tool for designers concerned with Signal Integrity.

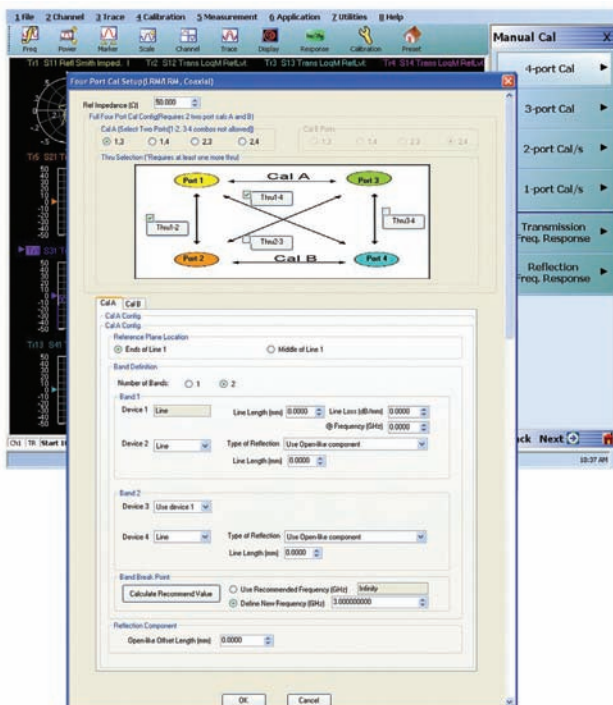

Advanced 4-port Capabilities

- 16 Single-ended S-parameters
- 16 Mixed-mode S-parameters
- Flexible Port Assignments
- Single-ended to balanced measurements
- 4-, 3-, 2-, and 1-port Calibrations using AutoCal (2-port), SOLT/R, SSLT/R, SSST/R, LRL/M, A-LRM
- Simultaneous 1-port or 2-port measurements
- Arbitrary Impedance Transformation
- Hybrid-Cal for combining 1- or 2-port calcs to create 2-, 3-, or 4-port calcs with the addition of Thru/ Reciprocal step/s. Ideal for mixed-media applications.
- Flex Cal for a calibration to be used for a lesser port correction, thus faster measurements
- Embedding and De-embedding of 2- or 4-port networks, using circuit elements or .snp files
- Extensive Network Extraction of one, two, or four 2-port networks, or two 4-port networks, including /2 capability for extracting fixtures that cannot be calibrated at the inner-plane

Connectivity Now and with the Future . . .

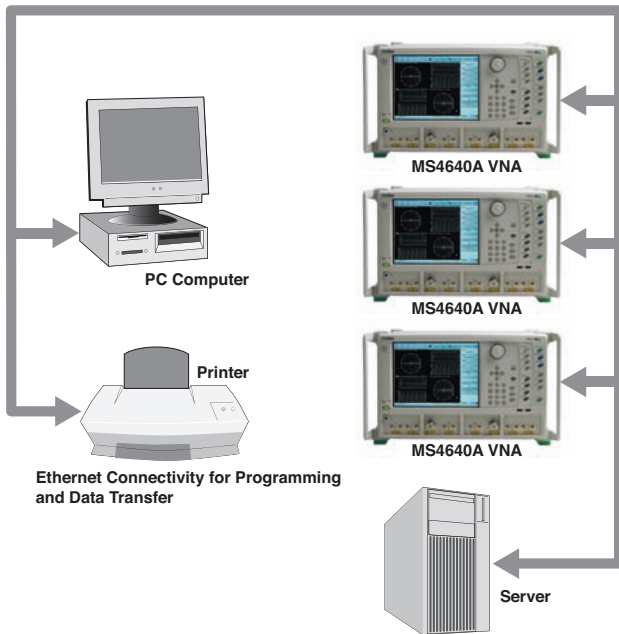

The VectorStar provides a unique set of interconnectivity tools in addition to multiple options of computer and printer interfaces. The range of interface capabilities include:

- LAN – Control the VectorStar over the LAN via VXI-11 or TCP/IP protocols. 10/100Base T Ethernet.
- USB – Use the TMC class protocol to connect to the VNA using a USB cable. One Type B USB 2.0 port for controlling the VectorStar externally. Four Type A USB 2.0 ports for peripherals such as keyboard, mouse, flash drives, hardware key, and others.
- GPIB via IEEE 488.2 – Compatible with previous generation Anritsu VNA and use your native GPIB commands
- Serial-ATA Hard Drive – Easily remove and replace from the rear panel.
- External I/O Port 25-pin D-Sub – Custom test set interface, and synchronize with different sweep states such as Start, Stop, Driven Port and others.
- Serial Port 9-pin D-Sub RS-232 – Control for AutoCal modules and other devices.
- IF Inputs/Outputs – Use with Millimeter-wave modules, antenna testing, and others.
- BNC connectors – Access directly to triggers, lock status, and others.

VectorStar is the first VNA to work near-seamlessly with AWR's Microwave Office®. Right on your desktop you have all of the tools essential for high-frequency IC, PCB, and module design, including:

- Linear circuit simulators
- Electromagnetic (EM) analysis tools
- Integrated schematic and layout

Easily embed VectorStar data into the designs you create in Microwave Office, and use the available software tools to accurately guide you to and through changes required in your circuits, measurements and test fixtures.

Integration of high-frequency design tools within high-performance VNAs is the way of the future – and available today with VectorStar, only from Anritsu.

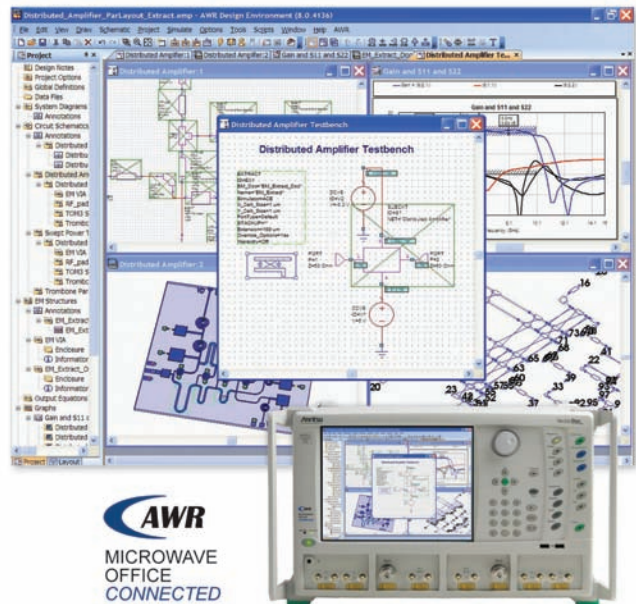

... A Vast Array of Powerful Measurement Tools

Embedding/De-embedding

The de-embedding capabilities of VectorStar can be used to remove test fixture contributions, modeled networks and other networks described by S-parameters (S2P files) from the measurements. Similarly, the Embedding function can simulate matching circuits for optimizing amplifier designs or simply adding effects of a known structure to a measurement. Changing the port and network orientations is easy, making embedding/de-embedding multiple networks straightforward and effortless.

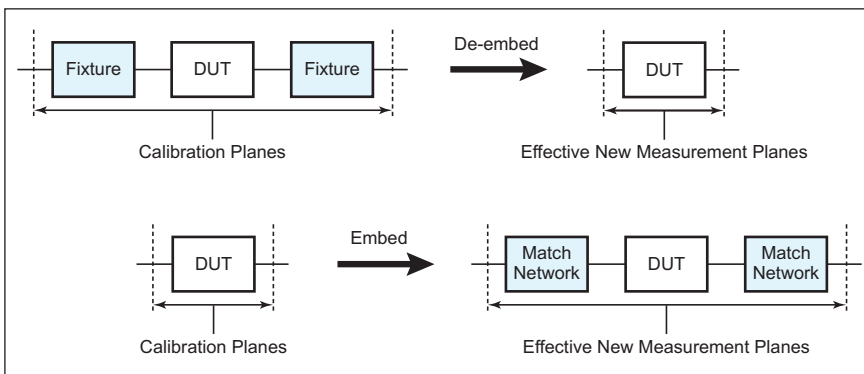

Adapter Removal

Quickly and easily characterize and “remove” the effects of an adapter attached during calibration and not used during device measurements. This de-embedding technique is useful when measuring non-insertable devices and optimizes the calibration procedure. Using this method requires only 2 normal insertable SOLT calibration. VectorStar retains both calibrations in internal memory and automatically extracts the effects of the adapter during measurement.

Test Port Power with Power Meter Accuracy

S-Parameter measurements of active devices, such as amplifiers, require accurate knowledge of the input and output power levels of the device. Also, for optimum swept frequency gain compression measurements, the output power of the analyzer test port should be flat over the frequency range. The MS4640A provides an automated power flatness calibration program for characterizing test port power. When calibrated with the Anritsu ML24XX series power meters, the calibration routine automatically stores a power correction table in the analyzer for later recall. The result is a VNA with flat, leveled power across the entire sweep range and with power meter accuracy.

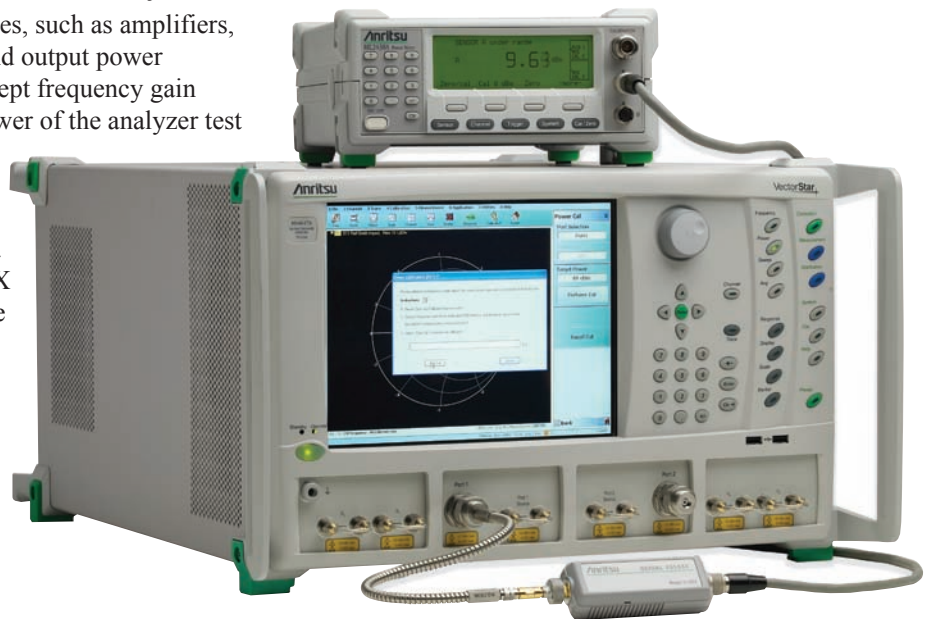

Choose the Ideal Configuration . . .

Application	Configuration		
	Standard	70 kHz Frequency Extension (Option 070)	Time Domain (Option 002)
Passive Devices (filters, attenuators, connectors)	<ul style="list-style-type: none"> Segmented sweep optimizes data point locations for optimum accuracy at critical points. Group Delay provides accurate phase performance characteristics over a defined frequency span. 	<ul style="list-style-type: none"> Characterize connectors with greater accuracy using the best low-pass time domain processing. Accurately measure devices below 500 MHz without degradation in dynamic range. 	<ul style="list-style-type: none"> Identify impedance mismatches within DUT. 70 kHz to 70 GHz and up to 100,000 points provides the best resolution and best non-aliasing range of any VNA.
Active Devices Low Power High Power	<ul style="list-style-type: none"> Complex limit lines provides complete flexibility in defining pass/fail tests. Quickly and accurately identify key points such as 3 dB and TOI points. 	<ul style="list-style-type: none"> Identify otherwise hidden low frequency anomalies such as bias circuit resonances and memory effects. 	<ul style="list-style-type: none"> Identify impedance mismatches within DUT.
Harmonic/IMD Measurements	<ul style="list-style-type: none"> Easily switch from a broad frequency range to a specific range of interest with marker sweep and multiple channels. 	<ul style="list-style-type: none"> Measure devices below 10 MHz with accuracy and precision without having to setup an additional test station. 	—
Mixers Up/Down Converters	<ul style="list-style-type: none"> Configure screen to display multiple frequency spans for different ports of frequency translated devices. 	<ul style="list-style-type: none"> Measure devices below 10 MHz with accuracy and precision without having to setup an additional test station. Supports low frequency IF mixers 	—
On-Wafer	<ul style="list-style-type: none"> Multiple calibration choices including: SOLT, TRL/LRL/LRM, Offset Shorts, SOLR, and Advanced-LRM 	<ul style="list-style-type: none"> Characterize devices over the broadest frequency range available in a single output. 	<ul style="list-style-type: none"> Low end harmonic frequency calibration of 700 kHz provides best start point for low pass time domain analysis. Obtain maximum available detailed information of device.

. . . For Any Application

Receiver Offset (Option 007)	Direct Access Loops (Option 051)	Active Measurement Suite (Option 06X)
—	<ul style="list-style-type: none"> • Configure to test two devices simultaneously. Match cables and filters for phase, group delay and amplitude. • Increase test port power with external amplifiers. 	<ul style="list-style-type: none"> • Option 061 includes: 2 attenuators; one in Source 1 path and one in Receive 2 path. • Option 062 provides: 4 attenuators; 2 in the source paths and 2 in the receive paths.
<ul style="list-style-type: none"> • Independent control of source and receiver for harmonic and IMD measurements 	<ul style="list-style-type: none"> • Use access loops to increase or decrease available port power through the use of external amplifiers. • Measure and match two amplifiers simultaneously. 	<ul style="list-style-type: none"> • Use internal attenuators to increase the source and receive power dynamic range. • Software measures compression at up to 401 frequency points and displays in graphical and tabular formats.
<ul style="list-style-type: none"> • Independent control of source and receiver for harmonic and IMD measurements 	<ul style="list-style-type: none"> • Use access loops to increase power drive levels. 	<ul style="list-style-type: none"> • Use internal bias tees to bias active devices while performing intermodulation measurements. • Use attenuator for dynamic range control.
<ul style="list-style-type: none"> • Multiple Source Control for separate LO frequencies • NxN Frequency Translated Measurement capability for accurate absolute measurements of magnitude and phase, and group delay. 	<ul style="list-style-type: none"> • Use access loops to insert mixer for 'Golden Standard' reference and matching. 	<ul style="list-style-type: none"> • Use attenuator for test port power range control.
<p>On-wafer mixers:</p> <ul style="list-style-type: none"> • Multiple Source Control for separate LO frequencies • NxN Frequency Translated Measurement capability for accurate absolute measurements of magnitude and phase, and group delay. 	<ul style="list-style-type: none"> • Bypass couplers between millimeter-wave modules and test set thereby maximizing dynamic range. 	<ul style="list-style-type: none"> • Use internal bias tees to bias active devices while performing intermodulation measurements. • Use attenuator for dynamic range control.

Calibration Kits and Accessories . . .

70 kHz to 70 GHz of Fully Specified, Traceable Measurements

Anritsu has pioneered metrology measurements using airline technology. Airlines establish the characteristic impedance of the measurement system and are traceable through mechanical measurements. Traceable beadless airlines are then used to confirm performance of a calibrated VNA. Anritsu has established a traceable path for airlines up to 70 GHz. A traceable path to 70 kHz has also been established by using DC coupled thermal power sensors. Thus, utilizing a combination of traceable Anritsu-designed thermal power sensors, and traceable 1.85 mm airlines, calibration and specifications covering the entire 70 kHz to 70 GHz range in a single sweep is achieved.

36580 Series AutoCal® and Precision AutoCal

The Anritsu 36580 series AutoCal modules are automatic calibrators that provide fast, repeatable and high quality coaxial calibrations up to 70 GHz. These modules contain precisely characterized calibration standards that aid in the removal of normal systematic errors of VNAs. These calibrators are ideal for the manufacturing environment where speed, accuracy, and reliability are important.



36585V Precision AutoCal

36581KKF AutoCal

3650 Series Calibration Kits

Accurate operation of your VectorStar analyzer is ensured by using Anritsu's precision coaxial SOLT (sliding load) calibration kits. These kits include precision components for calibrating measurements in SMA, 3.5 mm, K Connector® and V Connector®. For waveguide measurements, standard kits offer offset-short calibration capabilities. Anritsu's microstrip calibration kits include all the components necessary for SOLT, LRL, and LRM calibrations using the Anritsu 3680 series Universal Test Fixture.



3650 Series Coaxial Calibration Kits

3657 Series Multiple Line Calibration Kits

The Anritsu 3657 series Multiple Line Calibration kits provide six V Connector airlines ranging from 15.00 mm to 49.84 mm in length. All airlines are configured with male to male connectors. The airlines can be used to calibrate the VectorStar VNA using TRL/LRL/LRM/ calibration techniques. Using the proper combination of airline lengths and the VectorStar internal calibration routines, the VNA can be consistently calibrated to 50 dB directivity. Insertion and removal tools are also supplied with the kits. The kits can be provided with and without fixed offset shorts.



3657 Series Multiple Line Calibration Kits

3660 Series Verification Kits

Anritsu offers a complete line of coaxial verification kits to confirm your system's performance. All verification kits contain precision components with characteristics traceable to NIST. Verification kits can be kept in your metrology laboratory where they provide the most dependable means of checking system accuracy.



3660 Series Verification Kits

3680 Series Universal Test Fixtures (UTF)

Anritsu's Universal Test Fixture accommodates measurements in microstrip and coplanar waveguide. Spring-loaded jaws help to provide 0.1 dB repeatability on devices from 5 to 75 mils thick. Special fixtures are available for testing packaging transistors. An optional MMIC attachment helps you test integrated circuits.



3680 Series Universal Test Fixture

3670 and 3671 Series Test Port Cables

Anritsu offers laboratory quality semi-rigid and flexible test port cables for K and V connectors.

34 Series Test Port Converters

Test port converters allow you to change the connectors on the VNA's test ports. Converters are available for K and V connectors.

35 Series Waveguide-to-Coaxial Adapters

These precision waveguide-to-coax adapters transform standard or double-ridge waveguide to coaxial K or V connectors.

. . . from 70 kHz to 70 GHz and Beyond

Rear Panel Connections

AC Power Input	AC Input connector, with On/Off switch, and fuses 350 VA max., 90-264 VAC, 47-63 Hz (power factor controlled)	
System HDD	System Hard Drive Interface	
USB Control Port	Type B USB 2.0 port for controlling the instrument externally, for remote operation	
USB Ports	Two type A USB 2.0 Ports for peripherals such as keyboard, mouse, memory stick, hardware key, etc. (more USB ports at the front panel)	
Keyboard and Mouse Ports	Dedicated PS/2 ports. Could be used with USB keyboard and mouse via adapters, sparing USB 2.0 ports.	
LAN Port	10/100BaseT Ethernet	
GPIB Port (talker/listener)	Type D-24, female, IEEE 488.2 compatible, for controlling the instrument externally, for remote operation	
GPIB Port (dedicated controller)	Type D-24, female, for the control of external instruments such as power meters, external test sets, etc.	
External I/O Port	25-pin D-Sub, female, User-defined I/O for custom external test set interface, to synchronize with different sweep states, such as Start, Stop, Driven Port, etc.	
	Pin 1	Limit Pass/Fail
	Pin 2, 3, 15, 16	TTL In
	Pin 4, 13 14, 21	GND
	Pin 5-12, 17-20, 22	TTL Out
	Pin 23-25	Reserved
Serial Port	9-pin D-Sub, male, compatible with RS-232, provides control for AutoCal modules, etc.	
VGA Port	15-pin mini D-Sub, for simultaneously projecting the instrument's screen display onto an external VGA monitor, with 1024 x 768 min. resolution	
Bias Inputs (optional)	BNC (female), one per port (check option 06x)	
Bias Fuses (optional)	One per port. (0.5A, 250V)	
Direct Access Loops (optional)	For Source, Test and Receive paths, 3 per port, for < 2.5 GHz frequency coverage SMA (females) Damage Input Levels: +20 dBm max., 0 VDC max.	
IF Inputs/Outputs	a1, a2, b1, b2, IF Inputs/Outputs, SMA (females) Inputs used with external converters such as mmW modules, or for antenna testing. Outputs used with external IF digitizers and processors. Nominal Inputs: 5 to 20 MHz (mode dependant), 0 dBm for full scale Nominal Outputs: 0.2 to 100 MHz (mode dependant), +10 dBm max.	
10 MHz In	BNC (female), auto-sensing, better than 1000 ppm accuracy recommended. Signal: -10 dBm to +3 dBm, 50 Ω Nominal	
10 MHz Out	BNC (female), derived from the internal reference, unless an external 10 MHz reference input is applied. Signal: 0 ± 5 dBm sinusoidal, 50 Ω Nominal	
Analog In 1 & 2	BNC (females), two independent inputs for measurements simultaneous with the RF measurements, for current sensing, efficiency computation, power detection, etc. Range: -10 V to +10 V with automatic offset and gain calibrations Accuracy: 2 mV + 1% for $ V < 5$ V; 2% for $ V > 5$ V Nominal input impedance: 60 k Ω	
Ext Analog Out	BNC (female), for external attenuator control, external switch control, analog triggering assistance, measurement system integration and other purposes. Normal operating modes: Sawtooth sync sweep, TTL indication of driving port, open loop level controller. Range: -10 V to +10 V; low impedance drive Accuracy: 20 mV + 2% Load: > 5 k Ω	
Ext Trigger	BNC (female) 0-3.3 V input (5 V tolerant) High impedance (> 100 k Ω)	100 ns minimum input pulse width Programmable edge trigger
Lock Status	BNC (female) 0-3.3 V input (5 V tolerant) High impedance (> 100 k Ω)	100 ns minimum input pulse width Positive-edge trigger
Ready for Trigger	BNC (female) 0-3.3 V latched output Low impedance (~ 50 Ω)	Voh = 2 V min @ -12 mA Vol = 0.8 V max @ +12 mA
Trigger Out	BNC (female) 0-3.3 V pulse output 1 usec positive pulse	Low impedance (~ 50 Ω) Voh = 2 V min @ -12 mA Vol = 0.8 V max @ +12 mA

Ordering Information . . .

Instrument Models

Part Number	Description	More Information
MS4642A	Vector Network Analyzer 10 MHz to 20 GHz	Includes: - CD with Operation and Programming Manuals, Measurement Guide, and other technical publications in .pdf format, and miscellaneous utilities - DVD with Norton Ghost Backup Software - Microsoft Windows XP-Pro DVD (not for use with the VNA) - Mouse, USB, Optical - Power Cord
MS4644A	Vector Network Analyzer 10 MHz to 40 GHz	
MS4645A	Vector Network Analyzer 10 MHz to 50 GHz	
MS4647A	Vector Network Analyzer 10 MHz to 70 GHz	
ME7828A	Vector Network Analyzer 10 MHz to 110/500 GHz and beyond	Consult the ME7828A Datasheet

4-port Test Sets

Part Number	Description	More Information
MN4694B	4-port Test Set, K	For MS4642A and MS4644A
MN4697B	4-port Test Set, V	For MS4645A and MS4647A

Options

Part Number	Description	More Information
MS4640A-001	Rack Mount Option	Adds handles and removes feet for shelf-mounting, into a 19" universal rack.
MS4640A-002	Time Domain	
MS4640A-004	Hard Drive, Serial-ATA, with OS	Additional HD, Pluggable at rear panel
MS4640A-007	Receiver Offset	
MS464xA-051	Direct Access Loops	Not available with options 061, 062; Model-dependent
MS464xA-061	Active Measurements Suite	with 2 Step Attenuators; Model-dependent
MS464xA-062		with 4 Step Attenuators; Model-dependent
MS4640A-070	70 kHz Low-End Frequency Extension	
MS4640A-098	Z540/Guide 25 Calibration, No Data	
MS4640A-099	Premium Calibration, With Data	

Automatic Calibrators, Precision AutoCal

Part Number	Description	More Information
36585K-2M	K Precision AutoCal 70 kHz to 40 GHz	K (male) to K (male)
36585K-2F		K (female) to K (female)
36585K-2MF		K (male) to K (female)
36585V-2M	V Precision AutoCal 70 kHz to 70 GHz	V (male) to V (male)
36585V-2F		V (female) to V (female)
36585V-2MF		V (male) to V (female)

Automatic Calibrators, Standard AutoCal

Part Number	Description	More Information
36581KKF	K Standard AutoCal, 40 MHz to 20 GHz	K (male) to K (female)
36583S	Matched Adapters Set	SMA
36583L		3.5 mm
36583K		K

Calibration Kits, Mechanical

Part Number	Description	More Information
3650A	SMA/3.5 mm Calibration Kit	Without Sliding Loads
3650A-1		With Sliding Loads
3652A	K Calibration Kit	Without Sliding Loads
3652A-1		With Sliding Loads
3654D	V Calibration Kit	Without Sliding Loads
3654D-1		With Sliding Loads
3657	V Multi-Line Calibration Kit	Without Shorts
3657-1		With Shorts

Verification Kits

Part Number	Description	More Information
3666-1	SMA/3.5 mm Verification Kit	
3668-1	K Verification Kit	
3669B-1	V Verification Kit	

Test Port Cables, Ruggedized Semi-rigid

Part Number	Description	More Information
3670K50-1	K (female) to K (male), 1 each	30.5 cm (12")
3670K50-2		61.0 cm (24")
3670V50A-1	V (female) to V (male), 1 each	30.5 cm (12"), rated to 70 GHz
3670V50A-2		61.0 cm (24"), rated to 70 GHz

Test Port Cables, Flexible, Phase Stable

Part Number	Description	More Information
3671S50-1	K* (female) to 3.5 mm (male), 2 each	63.5 cm (25")
3671K50-1	K* (female) to K (male), 2 each	63.5 cm (25")
3671K50-2	K* (female) to K (male), 1 each	96.5 cm (38")
3671K50-3	K* (female) to K (male), 1 each, and K* (female) to K (female), 1 each	63.5 cm (25") 63.5 cm (25")
3671V50B-1	V* (female) to V (male), 2 each	63.5 cm (25"), rated to 67 GHz
3671V50B-2	V* (female) to V (male), 1 each	96.5 cm (38"), rated to 67 GHz

* Ruggedized style for VNA test ports. Does not fit standard male connectors.

Test Port Converters, to change or replace VNA test ports

Part Number	Description	More Information
34YK50C	Universal Test Port Connector to K (male)	Using 01-202 wrench (not included)
34YV50C	Universal Test Port Connector to V (male)	Using 01-202 wrench (not included)

Universal Test Fixture

Part Number	Description	More Information
3680-20	UTF	DC to 20 GHz
3680K		DC to 40 GHz
3680V		DC to 60 GHz
36801K	Right Angle Launcher	DC to 30 GHz
36801V		DC to 50 GHz
36803	Bias Probe	
36804B-10M	Microstrip Calibration/Verification Kit	10 mil, DC to 50 GHz
36804B-15M		15 mil, DC to 30 GHz
36804B-25M		25 mil, DC to 15 GHz

Precision Fixed Attenuators, Adapters (in and out of series, waveguide to coaxial), and more

Part Number	More Information
11410-00235	Refer to our extensive Precision RF & Microwave Components Catalog

Anritsu Corporation

5-1-1 Onna, Atsugi-shi, Kanagawa, 243-8555 Japan
Phone: +81-46-223-1111
Fax: +81-46-296-1264

• U.S.A.

Anritsu Company

1155 East Collins Blvd., Suite 100, Richardson,
TX 75081, U.S.A.
Toll Free: 1-800-267-4878
Phone: +1-972-644-1777
Fax: +1-972-671-1877

• Canada

Anritsu Electronics Ltd.

700 Silver Seven Road, Suite 120, Kanata,
Ontario K2V 1C3, Canada
Phone: +1-613-591-2003
Fax: +1-613-591-1006

• Brazil

Anritsu Eletrônica Ltda.

Praca Amadeu Amaral, 27 - 1 Andar
01327-010-Paraiso-São Paulo-Brazil
Phone: +55-11-3283-2511
Fax: +55-11-3288-6940

• Mexico

Anritsu Company, S.A. de C.V.

Av. Ejército Nacional No. 579 Piso 9, Col. Granada
11520 México, D.F., México
Phone: +52-55-1101-2370
Fax: +52-55-5254-3147

• U.K.

Anritsu EMEA Ltd.

200 Capability Green, Luton, Bedfordshire, LU1 3LU, U.K.
Phone: +44-1582-433200
Fax: +44-1582-731303

• France

Anritsu S.A.

16/18 avenue du Québec-SILIC 720
91961 COURTABOEUF CEDEX, France
Phone: +33-1-60-92-15-50
Fax: +33-1-64-46-10-65

• Germany

Anritsu GmbH

Nemetschek Haus, Konrad-Zuse-Platz 1
81829 München, Germany
Phone: +49-89-442308-0
Fax: +49-89-442308-55

• Italy

Anritsu S.p.A.

Via Elio Vittorini 129, 00144 Roma, Italy
Phone: +39-6-509-9711
Fax: +39-6-502-2425

• Sweden

Anritsu AB

Borgafjordsgatan 13, 164 40 KISTA, Sweden
Phone: +46-8-534-707-00
Fax: +46-8-534-707-30

• Finland

Anritsu AB

Teknobulevardi 3-5, FI-01530 VANTAA, Finland
Phone: +358-20-741-8100
Fax: +358-20-741-8111

• Denmark

Anritsu A/S

Kirkebjerg Allé 90, DK-2605 Brøndby, Denmark
Phone: +45-72112200
Fax: +45-72112210

• Spain

Anritsu EMEA Ltd.

Oficina de Representación en España
Edificio Veganova
Avda de la Vega, n° 1 (edf 8, pl 1, of 8)
28108 ALCOBENDAS - Madrid, Spain
Phone: +34-914905761
Fax: +34-914905762

• Russia

Anritsu EMEA Ltd.

Representation Office in Russia
Tverskaya str. 16/2, bld. 1, 7th floor.
Russia, 125009, Moscow
Phone: +7-495-363-1694
Fax: +7-495-935-8962

• United Arab Emirates

Anritsu EMEA Ltd.

Dubai Liaison Office
P O Box 500413 - Dubai Internet City
Al Thuraya Building, Tower 1, Suit 701, 7th Floor
Dubai, United Arab Emirates
Phone: +971-4-3670352
Fax: +971-4-3688460

• Singapore

Anritsu Pte. Ltd.

60 Alexandra Terrace, #02-08, The Comtech (Lobby A)
Singapore 118502
Phone: +65-6282-2400
Fax: +65-6282-2533

• India

Anritsu Pte. Ltd.

India Branch Office

3rd Floor, Shri Lakshminarayan Niwas,
#2726, 80 ft Road, HAL 3rd Stage, Bangalore - 560 075, India
Phone: +91-80-4058-1300
Fax: +91-80-4058-1301

• P.R. China (Hong Kong)

Anritsu Company Ltd.

Units 4 & 5, 28th Floor, Greenfield Tower, Concordia Plaza,
No. 1 Science Museum Road, Tsim Sha Tsui East,
Kowloon, Hong Kong
Phone: +852-2301-4980
Fax: +852-2301-3545

• P.R. China (Beijing)

Anritsu Company Ltd.

Beijing Representative Office

Room 2008, Beijing Fortune Building,
No. 5, Dong-San-Huan Bei Road,
Chao-Yang District, Beijing 10004, P.R. China
Phone: +86-10-6590-9230
Fax: +86-10-6590-9235

• Korea

Anritsu Corporation, Ltd.

8F Hyunjuk Building, 832-41, Yeoksam Dong,
Kangnam-ku, Seoul, 135-080, Korea
Phone: +82-2-553-6603
Fax: +82-2-553-6604

• Australia

Anritsu Pty. Ltd.

Unit 21/270 Ferntree Gully Road, Notting Hill,
Victoria 3168, Australia
Phone: +61-3-9558-8177
Fax: +61-3-9558-8255

• Taiwan

Anritsu Company Inc.

7F, No. 316, Sec. 1, Neihu Rd., Taipei 114, Taiwan
Phone: +886-2-8751-1816
Fax: +886-2-8751-1817

Please Contact: